





P A R A G O N
S T U D I O





Introduction	6
Classic Range	16
Diabolo Dumbbells	Folding Wall Bar
Luxury Kettlebells	Pull Up Bar
Hand Weights	Gym Rug
Club Dumbbells	Ballet Barre
Weight Plates	Leather Medicine Ball
Adjustable Bench	Wooden Plyo Box
Fixed Bench	Skipping Rope
Studio Accessories	32
Cork Yoga Mat	Resistance Loops
Cork Yoga Block	Pilates Ankle Weights
Cork Yoga Roller	Pilates Ball
Hemp Yoga Bolster	Pilates Ring
Yoga Blanket	Pilates Hand Weights
Resistance Bands	Mocha Kettlebell
Boxing	46
Boxing Gloves	Punch Bag
Pro Focus Pads	
Storage Solutions	52
Dumbbell Rack	Wall Unit Panels
Dumbbell Wall Rack	Wall Hardware
Dumbbell Tree Rack	Credenza
Multistorage Rack	Ball Holder
Kettlebell Wall Rack	Olympic Weight Pin
Kettlebell Tree Rack	Hand Weight Tree
Material Options	66
Custom Options	74
Case Studies	82
Partnerships	92
Designers Area	98

Introduction





Paragon Studio was built on a single idea: that wellness spaces deserve the same consideration as any other room in an exceptional home.

Our Core Product Range is made by hand in our UK workshop, using FSC-certified timber, recycled steel, and materials chosen as carefully as the clients we work with. We don't believe in catalogue finishes and mass production. We work alongside each client until the result is entirely their own, functional in the truest sense and built to last a lifetime.

Our Design Process

When we are working on developing new products for our range, our aim is to put function first and then design the form around it. This results in gym equipment that is more than just an ornament - each piece is made for tough workouts.

Once a product is ready to be prototyped, our engineers will begin to discuss how we can integrate sustainable materials and processes into the build in order to cut emissions.

Because each piece is made to order, our team are able to approach a project with a blank canvas and incorporate any bespoke requirements a client has during the pre-production phase.

This gives us unrivalled flexibility within our range, which is loved by clients and designers worldwide. As we continue to innovate and make unique changes to our products as requested by individual clients, we are continually learning new techniques and making improvements to our core product range.



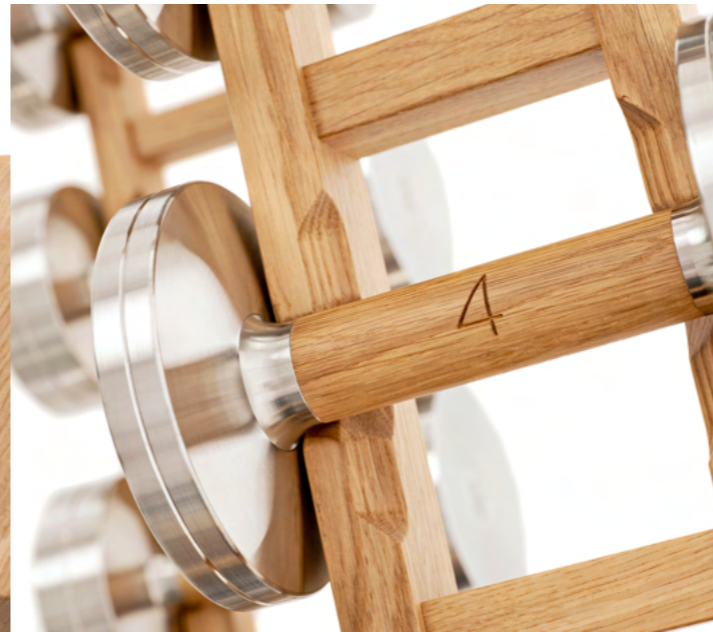

Route to Carbon Neutral

Our Diabolo Dumbbells are designed with environmental responsibility in mind. The inspiration behind our award-winning Diabolo Dumbbells was to create a beautifully crafted, high-quality product with sustainability at its core. Made from responsibly sourced materials and 100% recyclable, they reflect our commitment to reducing environmental impact without compromising on design or performance.

To ensure transparency, we partnered with an independent sustainability specialist to assess their full lifecycle. Carbon Managers conducted a comprehensive lifecycle assessment (LCA), measuring all greenhouse gas emissions and CO₂ equivalents (CO₂e) associated with manufacturing, packaging, distribution, use, and end of life.

This ongoing process allows us to better understand, reduce, and offset the impact of our products as we continue to evolve the range.

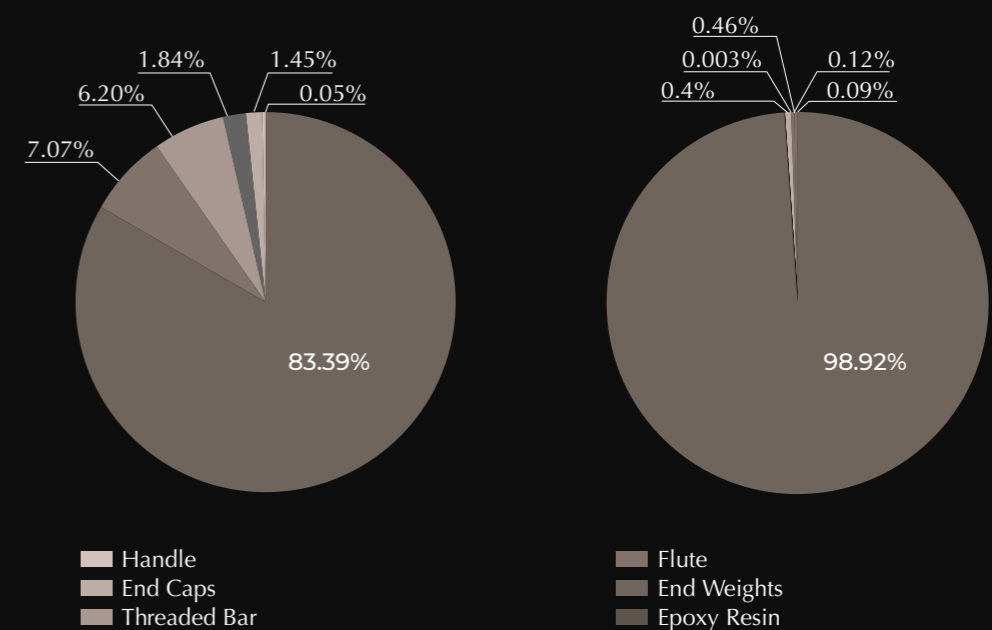
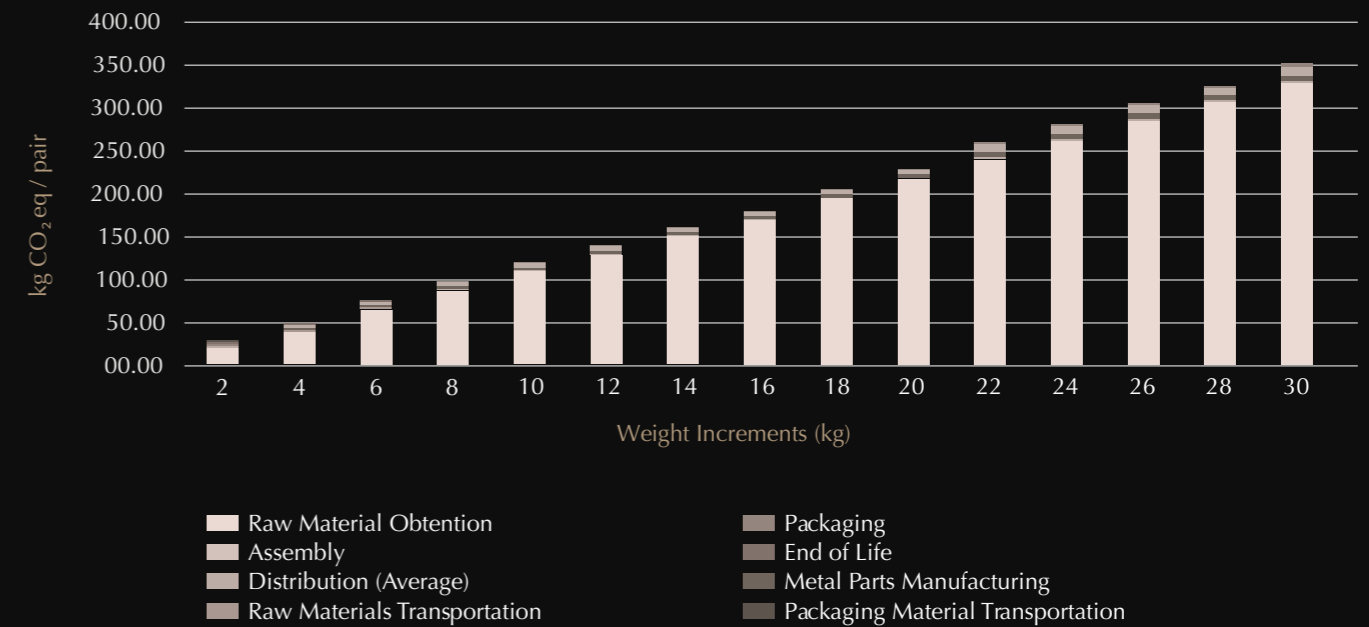

Classic Range





Diabolo Dumbbells

Prices from £4,076 (Ex VAT)

Our award winning Diabolo Dumbbells are the result of years of experience in the superyacht and prime property industries.

A truly over-engineered design, these dumbbells offer unparalleled levels of customisation and a uniquely concave end design. Choose our sustainable wooden handles and customise with laser engraving to add a touch of bespoke to your gym.

Finishes

Brushed

Custom Options

Monogrammed end plates, bespoke staining

Sets Available

2-30kg (2kg increments), 5-50lbs (5lbs increments)

Wood Options

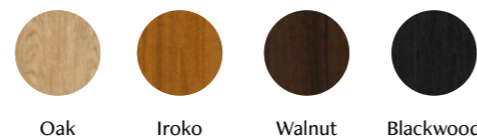

Oak Iroko Walnut Blackwood

Metal Options



Stainless Steel Bronzed Steel

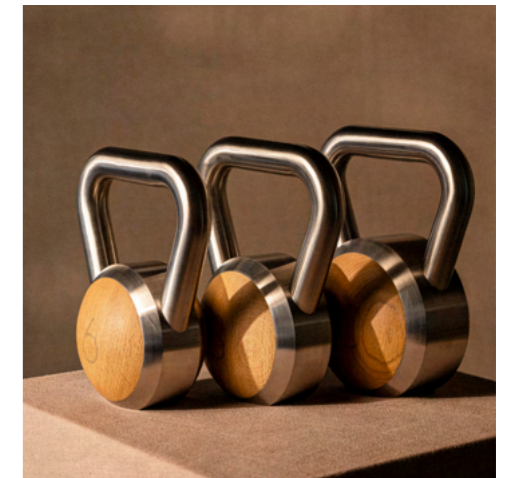
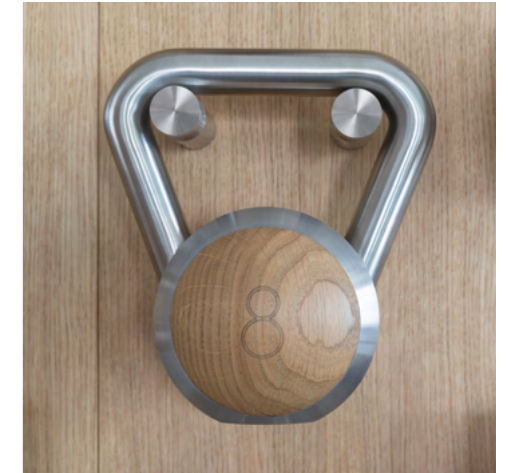

Luxury Kettlebells

Prices from £2,486 (Ex VAT)

Luxury Kettlebells made from stainless steel or aluminium bronze, with wooden inserts that can be matched to your interior. The smooth metal handle is the optimum solution for kettlebell swings, providing minimal friction during use and therefore a comfortable workout.

These kettlebells are sold in sets. Bespoke freestanding storage racks for your Luxury Kettlebells are also available in matching wood and metal finishes.

Finishes

Brushed

Custom Options

Monogrammed end plates, bespoke staining

Sets Available

4-24kg (2kg increments), 10-50lbs (5lbs increments)

Wood Options



Oak Iroko Walnut Blackwood

Metal Options



Stainless Steel Bronzed Steel

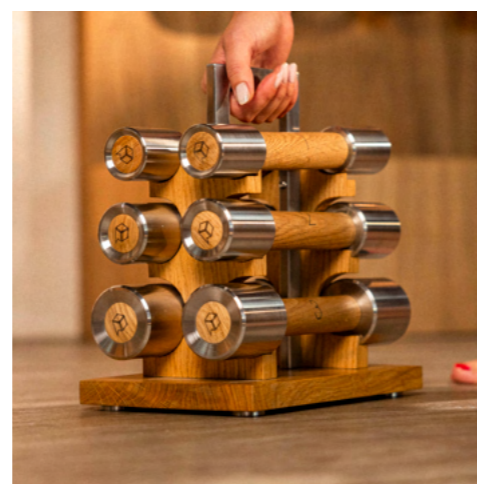

Hand Weights

Prices from £1,030 (Ex VAT)

Our Hand Weights kit is a neat set of Pilates hand weights designed to be used for toning and light weight exercises.

The 1, 2 and 3kg Hand Weights are stored on a portable rack, which can be displayed on a tabletop or shelf in the gym. This also includes a carry handle so the Hand Weights could be taken outside or to another workout location.

Finishes

Brushed

Custom Options

Monogrammed handle, bespoke staining

Sets Available

1kg, 2kg, 3kg hand weights

Wood Options

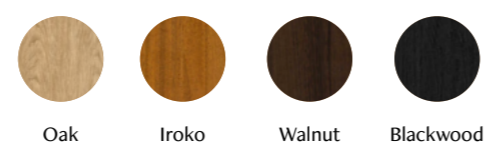

Metal Options



Club Dumbbells

Prices from £2,528 (Ex VAT)

Eye catching round weights made from stainless steel, with a highly researched soft-touch knurling pattern on the handles that offers superior grip and amazing comfort for users hands.

The Paragon Studio Club Dumbbells are fully customisable with all of our 4 standard woods or a bespoke finish, and clients can choose to have the end discs engraved. Minimum Order Quantity is 5 pairs of weights.

Custom Options

Monogrammed end plates, bespoke staining

Sets Available

5 Pair (2.5-12.5kg), 6 Pair (2.5-15kg), 10 Pair (2.5-25kg), 12 Pair (2.5-30kg), 15 Pair (2.5-37.5kg)
5 Pair (5-25lb), 6 Pair (5-30lb), 10 Pair (5-50lb), 12 Pair (5-52lb), 15 Pair (5-66lb)

Wood Options



Metal Options





Weight Plates

Prices from **£4,814** (Ex VAT)

Made-to-order, these beautifully crafted weights have customisable central inserts, which can be made bespoke for each individual client and space.

Available in a variety of industry-standard increments, a plethora of strength training routines can be performed using these disks along with your choice of Olympic Bar.

Finishes

Brushed

Custom Options

Monogrammed logo, bespoke staining

Sets Available

1.25kg, 2.5kg, 5kg, 10kg, 15kg, 20kg, 25kg

2.5lb, 5lb, 10lb, 25lb, 35lb, 45lb

Wood Options



Metal Options

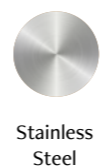

Adjustable Bench



Prices from **£3,406** (Ex VAT)

Paragon Studio benches are made to deliver exceptional stability, performance and aesthetics, even through the most demanding training sessions. Built on a solid four-point frame, the Adjustable Bench provides a secure, commercial-grade feel while complementing luxury residential, commercial or superyacht interiors.

Finishes

Brushed

Custom Options

Bespoke staining, logo emboss

Max User Weight

120kg / 265lb

Wood Options



Leather Options



Metal Options

**Leather is a natural material and shades may vary*



Fixed Bench

Prices from £2,646 (Ex VAT)

A gym bench must be robust, strong and stable. Our Paragon Studio Fixed Bench has all these qualities so our clients feel confident with every movement.

Once our design team perfected the function of the bench, they then incorporated all its luxurious elements for a truly bespoke piece.

Finishes

Brushed

Custom Options

Bespoke staining, logo emboss

Max Weight

120kg / 265lb

Wood Options



Leather Options

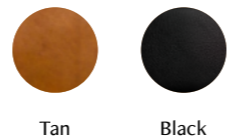

**Leather is a natural material and shades may vary*



Folding Wall Bar

Prices from £5,026 (Ex VAT)

A beautiful wooden wall bar with a folding top bar which is perfect for suspension and body weight training. Available in a multitude of standard and bespoke finishes, this piece of gym equipment is as much a sculptural joinery element in the room as it is a functional piece of fitness equipment.

Finishes

Brushed

Custom Options

Bespoke staining

Max User Weight

120kg / 265lb

Wood Options



Metal Options





Pull Up Bar

Prices from **£860** (Ex VAT)

The Paragon Studio Pull Up Bar is designed to bring effective bodyweight strength training. Wall mounted for stability, it provides a secure platform for pull-ups, chin ups and hanging core work, allowing you to train with confidence while maintaining a minimal aesthetic.

Simple and strong, it reflects the Paragon Studio approach to training equipment: purposeful design that supports focused, effective movement.

Custom Options

Bespoke staining

Max Weight

120kg / 265lb

Wood Options



Oak

Iroko

Walnut

Blackwood

Metal Options



Stainless Steel

Bronzed Steel



Gym Rug

Prices from **£550 p/m²** (Ex VAT)

Introducing our exclusive performance Rug Collection, designed to bring sophistication, durability, and functionality to elite gym spaces.

Inspired by our clients, this product allows Interior Designers and homeowners to specify their preferred timber floors in their gym spaces – providing a seamless and customisable alternative for loose laid rubber floor tiles required to protect the wood in the free-weights area.

Custom Options

Customisable in size and finish options

Build Up

8mm PET carpet - made from recycled plastic bottles

Care & Maintenance

Can be scrubbed and bleached or professionally cleaned

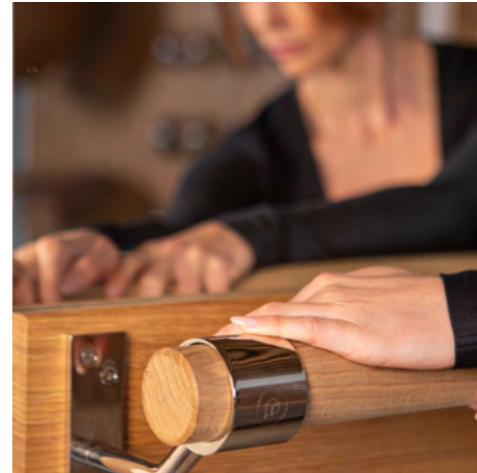

Ballet Barre

Prices from £POA (Ex VAT)

The epitome of elegance and functionality in the world of ballet at home: our Ballet Barre. Crafted with precision and passion, this exquisite piece seamlessly marries the grace of ballet with the sophistication of luxury craftsmanship.

Available in a selection of fine woods including Oak, Iroko, Walnut, or Blackwood, each barre exudes its own unique charm and character.

Finishes

Brushed

Custom Options

Bespoke staining

Max Weight

120kg / 265lb

Wood Options



Oak Iroko Walnut Blackwood

Metal Options



Stainless Steel Bronzed Steel

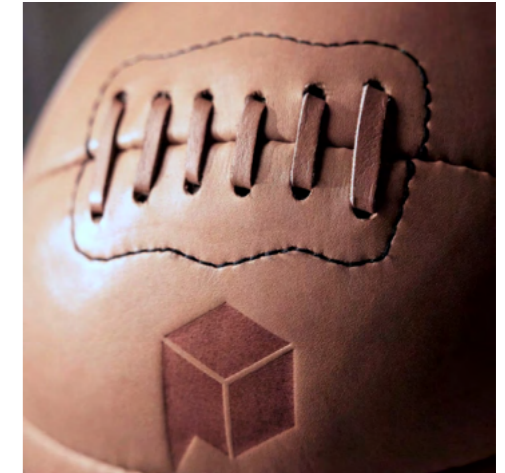

Leather Medicine Ball

Prices from £72 (Ex VAT)

Finished with the finest materials and hand-stitched, our Classic Leather Medicine Balls have a timeless retro design.

When paired with the rest of the Paragon Studio collection, the combination of the natural and premium materials creates a truly unique gym.

Leather Options

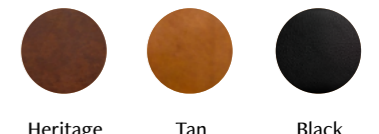

Heritage Brown Tan Black

Custom Options

Bespoke logo emboss

Weights

4lb, 8lb, 12lb, 16lb, 20lb

**Leather is a natural material and shades may vary*



Wooden Plyo Box

Prices from **£3,290** (Ex VAT)

Our 3 Side Plyo Box is designed for powerful workouts in a luxurious setting. It blends beautifully with the whole Paragon range, for complete unity within the gym.

Constructed with sustainably sourced wood, the Plyo Box finish is customisable by staining to offer a unique design.

Wood Options



Custom Options

Bespoke staining

Max Weight

120kg / 265lb



Skipping Rope

Prices from **£242** (Ex VAT)

Our Skipping Rope is the ultimate designer gym accessory with a stunning combination of wood, metal and leather.

This weighted skipping rope will test your upper body strength for a challenging workout.

Wood Options



Metal Options



Custom Options

Bespoke staining

Studio Accessories





Cork Yoga Mat

£59 (Ex VAT)

All the Paragon Studio yoga accessories have been designed with unparalleled aesthetics and comfort during all practices. The Cork Yoga Mat will seamlessly fit any residential or superyacht gym interiors alongside all other Paragon Studio products.

Easy to store and display, the Paragon Studio Cork Yoga Mat is the perfect addition to any bespoke fitness experience. Perform a plethora of fitness routines, from yoga, cardio and strength training on this luxury and bespoke mat.

Weight

2.4kg

Custom Options

Bespoke logo

Thickness

4.4mm

Material



Cork

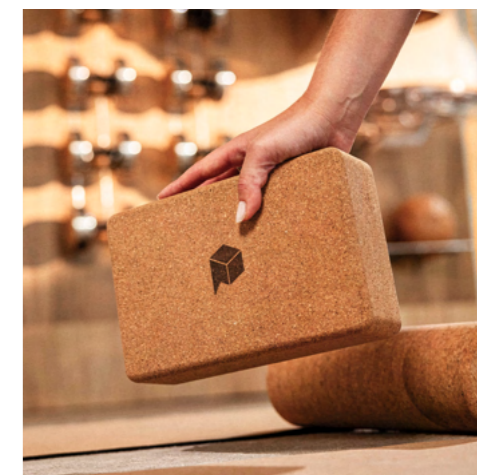

Cork Yoga Block

£36 (Ex VAT)

Paragon Studio's Cork Yoga Block has been designed with sustainability and comfort in mind. It offers users unparalleled support during practices, enhancing each individual movement.

A versatile piece of yoga equipment, perfect for use in both superyachts or prime properties, that offer exceptional aesthetics within your interiors, a must-have for the yoga enthusiast.

Weight

0.7kg

Custom Options

Bespoke logo

Material



Cork

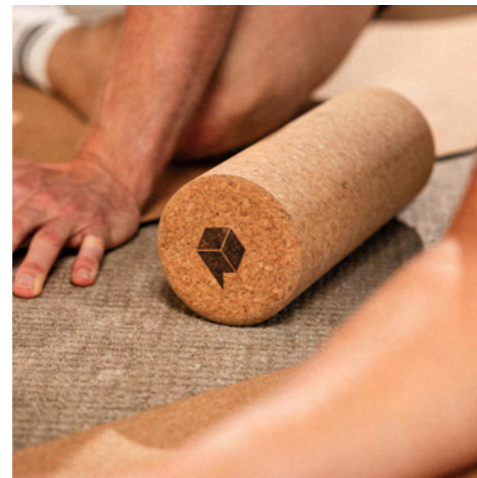
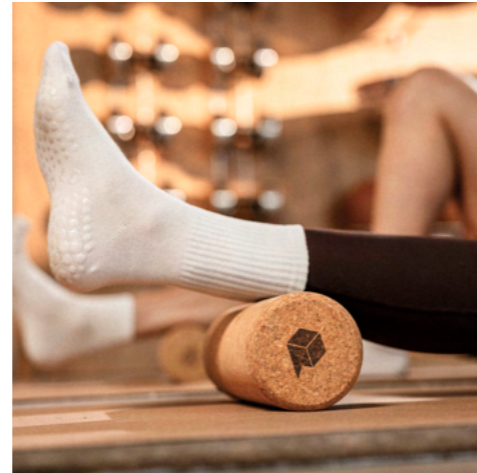

Cork Yoga Roller

£39 (Ex VAT)

The Paragon Studio Cork Yoga Roller has been beautifully designed to provide unmatched support and alignment during yoga practices. Our yoga accessories culminate together to provide a fulfilling wellness experience.

Its sleek and compact design guarantees ease of transportation between practices within your home or other facilities.

Material



Cork

Weight

0.85kg

Custom Options

Bespoke logo



Hemp Yoga Bolster

£78 (Ex VAT)

Bring comfort and balance to your yoga practice with the Paragon Studio Hemp Yoga Bolster. Designed to match the Paragon range, it features a soft neutral shade that blends into any space.

The outer cover is made from premium hemp fabric. It feels natural to the touch and is strong enough for everyday use. Inside, the bolster is filled with buckwheat hulls. They gently shape around your body to give support where you need it most.

Material



Hemp

Weight

4.5kg



Hemp Yoga Blanket

£65 (Ex VAT)

A refined essential for practice and home, the Paragon Studio Hemp Yoga Blanket offers structured support, natural warmth and understated design. Made from eco-conscious materials and finished with a clean, unbrushed texture, it folds or rolls with ease to enhance yoga, relaxation and everyday living within beautifully curated spaces.

Material



Hemp



Resistance Bands

£45 per set (Ex VAT)

These luxurious and eye-catching fabric resistance bands are designed primarily for home gym use – but are also great for commercial and hotel gyms.

The bands come in a set with 3 premium colours, are made from top quality material and offer 3 levels of resistance.

Material



Black Fabric

Beige Fabric

Grey Fabric

Resistance

Heavy, medium, light



Resistance Loops

£20 (Ex VAT)

A set of four flat resistance bands designed to support controlled strength, mobility and muscle activation through Pilates, sculpt and low-impact training.

Designed for performance and everyday versatility, the Paragon Studio Resistance Loops combine understated aesthetics with functionality. Made from durable latex with an anti-slip finish, each band delivers smooth, consistent resistance while remaining comfortable. The flat, minimalist profile allows for seamless integration into Pilates, sculpt and strength focused training.

Resistance

X Heavy, Heavy, Medium, Light

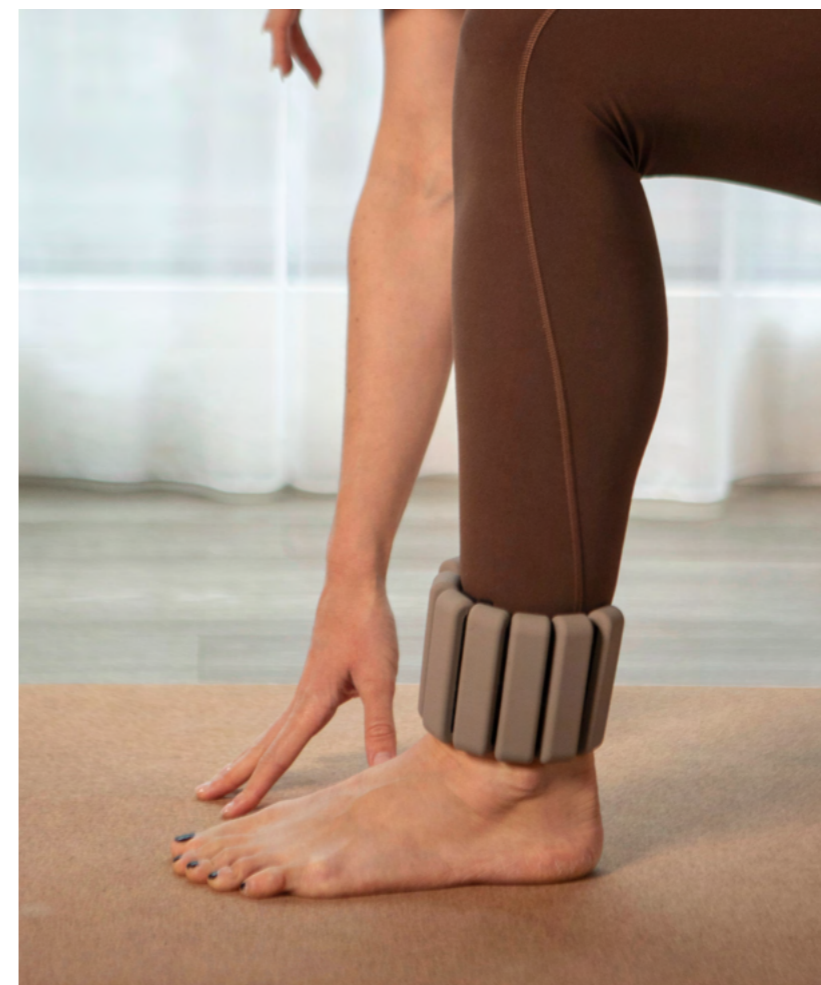

Pilates Ankle Weights

Prices from £26 (Ex VAT)

Elegant, sweat-proof Ankle Weights introduce gentle resistance to enhance movement without distraction. Made from soft sweat-proof silicone, they balance durability with comfort, allowing the body to move freely while maintaining a secure, supportive feel throughout every session.

The adjustable Velcro fastening ensures an effortless, tailored fit and the weighted design supports stability, strength and muscle tone through low-impact training. Ideal for Pilates, Barre, Yoga Sculpt, walking and light cardio, they transition seamlessly between practices and spaces.

Weight

0.5kg, 1kg, 1.5kg

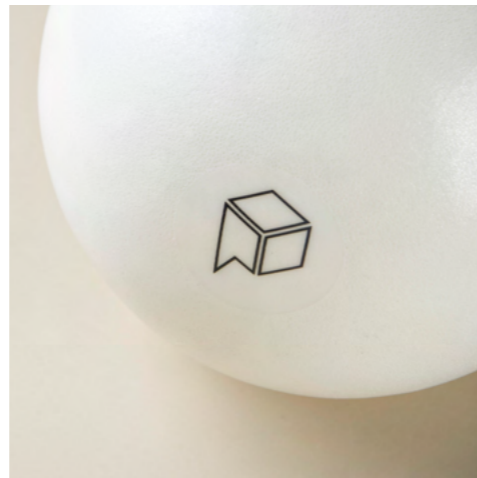

Pilates Ball

£10 (Ex VAT)

Designed to subtly elevate every Pilates session, the Paragon Studio Soft Pilates Ball introduces controlled instability that enhances core engagement, balance and postural awareness. It's form allows it to support or challenge the body with precision, whether placed behind the lower back, between the knees or ankles, or held in the hands, encouraging deeper muscle activation without interrupting the natural rhythm of movement.

Finished with an anti-slip surface and anti-burst construction for added safety, the ball offers reassurance as well as performance, gently deflating under pressure rather than bursting.

Dimensions

20cm diameter



Pilates Ring

£40 (Ex VAT)

A lightweight Pilates Ring or Magic Circle designed to subtly intensify mat-based training by adding gentle, controlled resistance that supports alignment, stability and full-body strength. Used between the hands or legs, it encourages deeper engagement through the arms, chest, inner thighs and core, refining technique while maintaining the natural flow of movement.

Soft-foam padded handles provide a comfortable, secure grip and allow for smooth transitions between exercises, making the ring approachable for a wide range of abilities. Easy to incorporate into existing routines at home or in the studio.

Dimensions

36cm diameter



Pilates Hand Weights

Prices from **£52** (Ex VAT)

Designed to build strength with precision and control, the Paragon Studio Sculpt Pilates Hand Weights bring subtle resistance to low-impact training. Carefully balanced to enhance stability, alignment and coordination, allowing you to increase intensity without compromising form, ideal for Pilates, Barre, Sculpt and strength-focused movement.

The smooth, comfortable grip supports secure handling through controlled sequences and extended sessions, encouraging fluid transitions and consistent technique.

Weights

1kg, 2kg



Mocha Kettlebell Set

£995 (Ex VAT)

Available in a set from 4-24kg, the Mocha Kettlebell set offers versatile weight progression for strength, conditioning, and functional training.

Inspired by the 2024 Pantone Color of the Year: Mocha Mousse, the Mocha Kettlebell set introduces a specially curated lineup of commercial-grade studio equipment in complementary neutral tones. Earth-inspired shades bring a sense of calm, warmth, and modern elegance - perfectly aligned with today's most coveted luxury gyms, Pilates studios, and boutique wellness spaces.

Weights

Set of 10, 4kg-24kg (2kg Increments)

Boxing





Boxing Gloves

Prices from £133 (Ex VAT)

Sophisticated in style and strong in design, the deluxe leather Boxing Gloves have all the classic features for a beautiful vintage feel.

When paired with the rest of the Paragon Studio collection, the combination of the natural and premium materials creates a harmonious gym environment.

Hand Size

Small - Medium (175 - 190 mm), Large - X Large (190 - 205 mm)

Weights

12oz (S/M), 14oz (L/XL)

Custom Options

Custom logo

Leather Options



Heritage Brown

Tan

Black

**Leather is a natural material and shades may vary*



Pro Focus Pads

£113 (Ex VAT)

The leather Pro Focus Pads are crafted to an exceptional standard for strength and durability during every training session.

The natural leather on the focus pads, blends perfectly with the sustainable materials featured across the Paragon Studio collection. For complete unity throughout the gym design, all boxing equipment comes in a range of leather finishes.

Leather Options



Heritage Brown

Tan

Black

**Leather is a natural material and shades may vary*





Punch Bag

Prices from £764 (Ex VAT)

Finding the perfect balance of strength and style for boxing equipment to complement the interiors within luxury gyms was challenging. With many products detracting from the beauty of the gym design, the deluxe leather Punch Bag is a durable, functional solution, made with natural materials in multiple leather finishes.

Leather Options



Heritage Brown



Tan



Black

Sizes

3ft, 4ft, 5ft

Custom Options

Custom logo

**Leather is a natural material and shades may vary*



Storage Solutions





Dumbbell Rack

Prices from £2,784 (Ex VAT)

Our horizontal Dumbbell Rack not only protects and neatly stores each dumbbell, but also allows the free weights to be showcased safely for all to admire.

The wood and metal finishes of the rack will match those of our bespoke dumbbells for a seamless design throughout the gym.

Wood Options

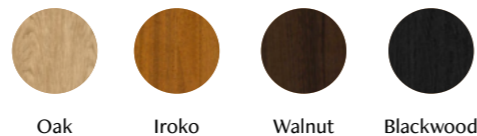

Oak Iroko Walnut Blackwood

Metal Options

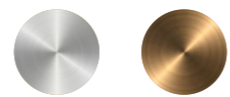

Stainless Steel Bronzed Steel

Configurations

Pairs of 5, 6, 10, 12, 15

Custom Options

Freestanding, wall fixed, sea-fastening brackets

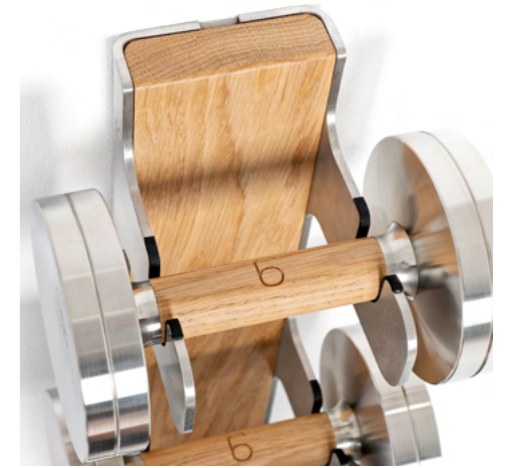

Dumbbell Wall Rack

Prices from £1,876 (Ex VAT)

When storage is at a premium, wall mounting can be a great option. Beautifully presenting free weights, our Paragon Studio Dumbbell Wall Rack securely holds the dumbbells in place.

Each rack is bespoke and created using materials featured on the dumbbells and throughout the gym design.

Wood Options



Oak Iroko Walnut Blackwood

Metal Options



Stainless Steel Bronzed Steel

Configurations

Pairs of 3, 4, 5

Custom Options

Freestanding, sea-fastening brackets



Dumbbell Tree Rack

Prices from £2,956 (Ex VAT)

When developing our range of racks, creating space saving storage solutions was a priority for the design team as this is a restriction with many of our superyacht clients.

The Dumbbell Tree Rack can hold 5, 6, 7 or 8 pairs of dumbbells either from our own range, or we can design a custom piece to complement a specific choice of free weights.

Wood Options



Oak Iroko Walnut Blackwood

Metal Options



Stainless Steel Bronzed Steel

Configurations

Pairs of 5, 6, 7, 8

Custom Options

Sea-fastening brackets

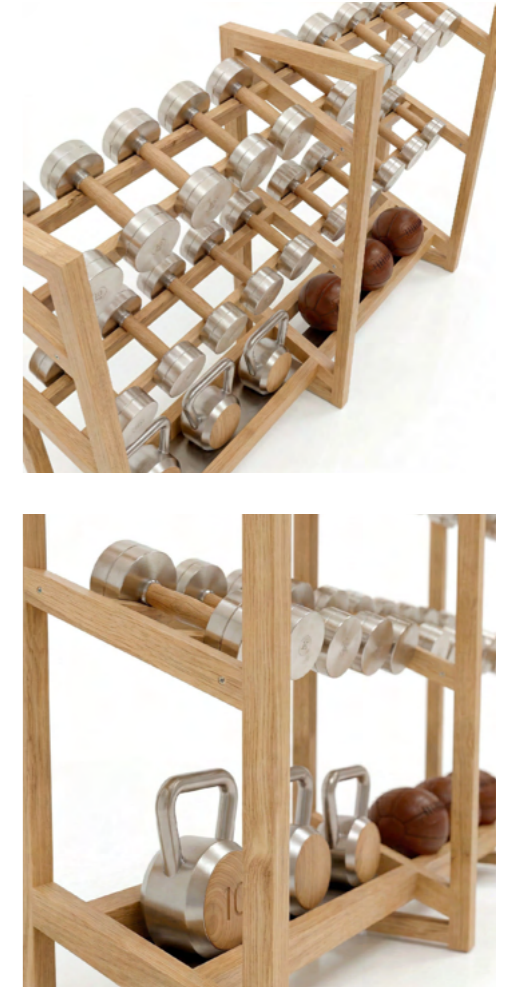

Multistorage Rack

Prices from £POA (Ex VAT)

Our Multistorage Rack is a 3 tier version of our horizontal Dumbbell Rack, with the capacity to hold 10 Pairs of our Diabolo Dumbbells, 3 Luxury Kettlebells and 3 Leather Medicine Balls.

The Multistorage rack is available in all 4 of our standard wood finishes, with both Steel or Bronze hardware; and must be wall fastened to ensure stability and safety.

Wood Options



Oak Iroko Walnut Blackwood

Metal Options



Stainless Steel Bronzed Steel

Configurations

Multiple configurations available

Custom Options

Freestanding, wall fixed, sea-fastening brackets

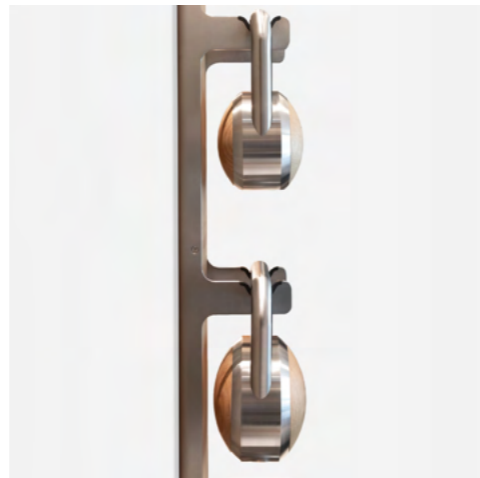
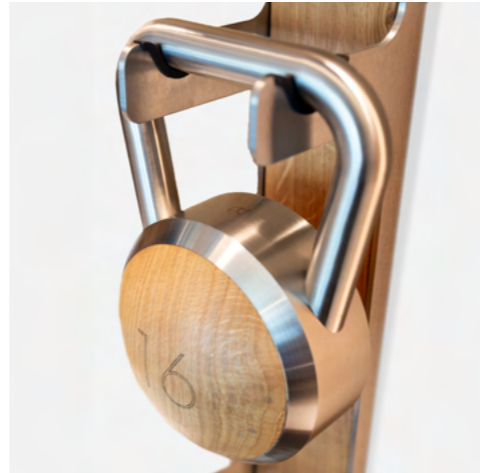
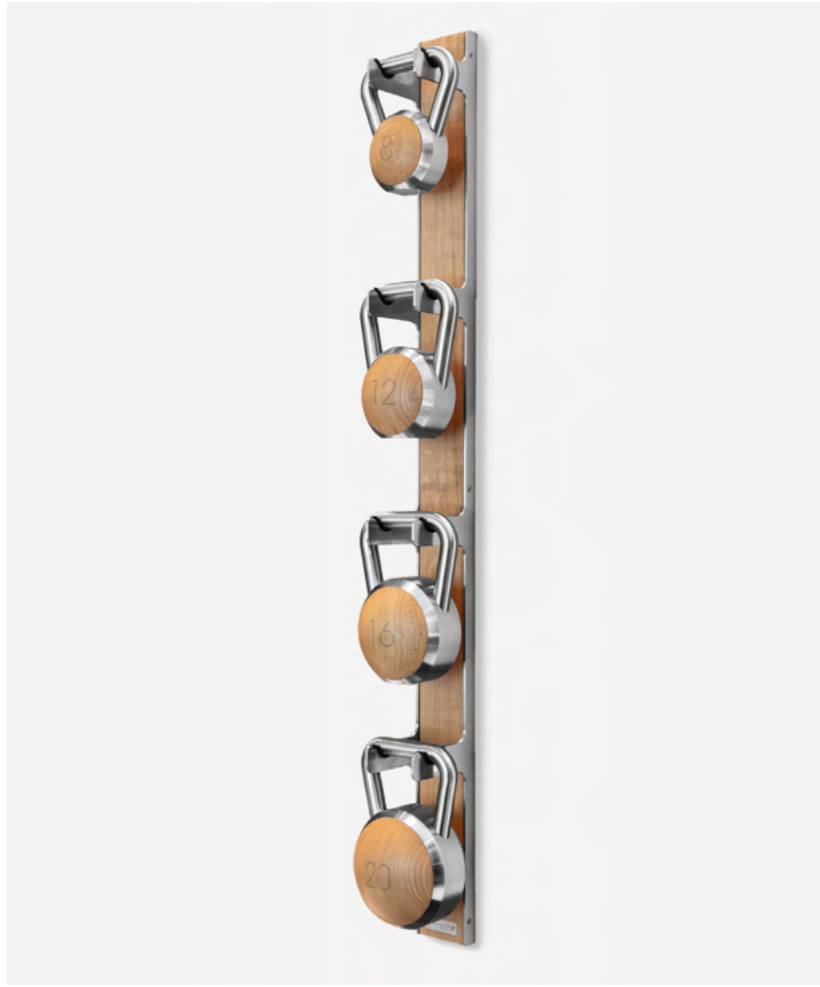

Kettlebell Wall Rack

Prices from £2,300 (Ex VAT)

When floor space is at a premium, wall mounting weights can be a great option. Beautifully presented, our Paragon Studio Kettlebell Wall Rack securely holds the weights in place vertically.

Each rack is bespoke and created using materials featured on the kettlebells and throughout the gym design.

Wood Options

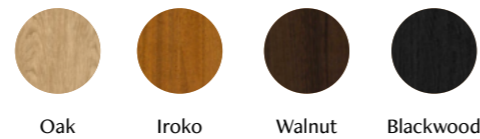

Oak Iroko Walnut Blackwood

Metal Options



Stainless Steel Bronzed Steel

Configurations

4 or 5

Custom Options

Sea-fastening brackets



Kettlebell Tree Rack

Prices from £2,448 (Ex VAT)

The ultimate solution for stylish and efficient kettlebell storage. Our Kettlebell Tree Rack is designed to hold 4 or 6 Luxury Kettlebells vertically; this exquisite rack is perfect for maximising space in your gym while adding a touch of sophistication.

Crafted with meticulous attention to detail, the Paragon Studio Kettlebell Tree Rack is available in a selection of premium woods: Oak, Iroko, Walnut, and Blackwood.

Wood Options



Oak Iroko Walnut Blackwood

Metal Options



Stainless Steel Bronzed Steel

Configurations

4 or 6

Custom Options

Sea-fastening brackets

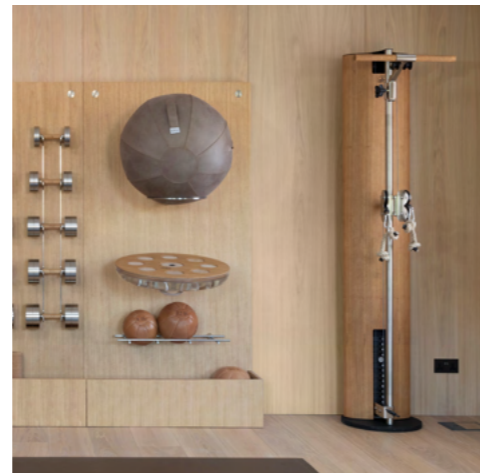
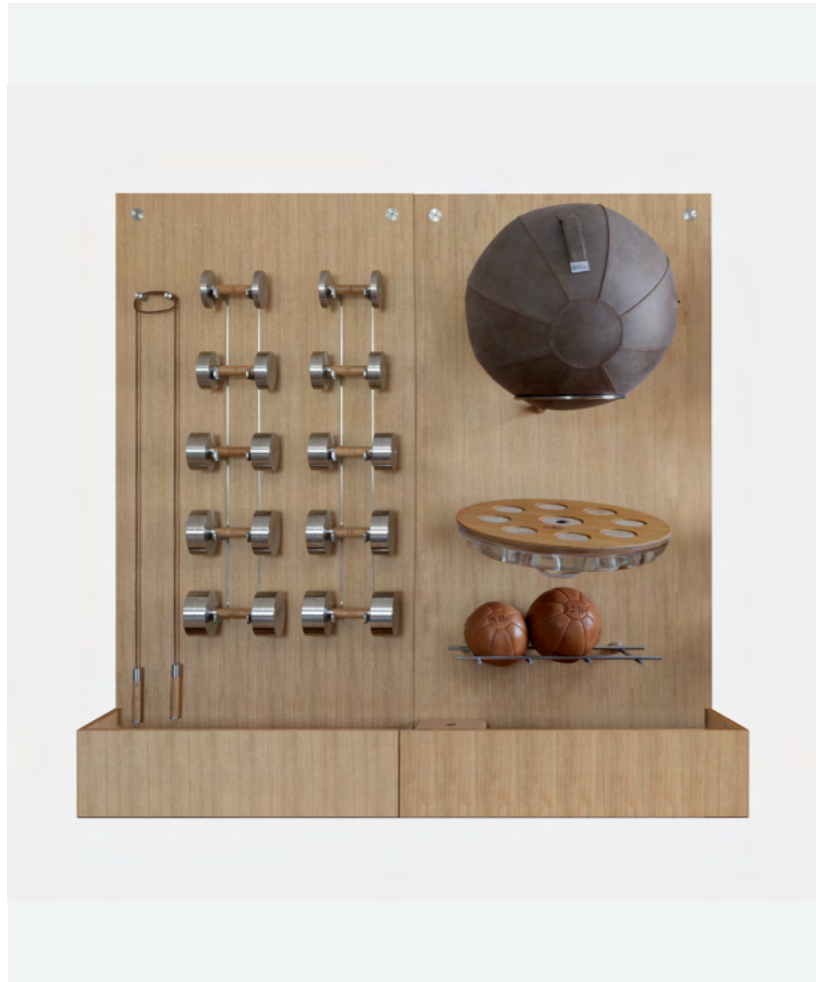

Wall Unit Panels

Prices from £13,543 (Ex VAT)

A space-saving, modular unit designed to be wall hung, which displays your equipment beautifully to be admired in your home gym.

Vertically stored accessories and weights are held securely on machined steel brackets, and at the base of the unit we have included some neat accessory storage boxes with soft cork lining so you can store all your loose gym items out of site and keep your gym clutter free.

Wood Options



Oak Iroko Walnut Blackwood

Metal Options



Stainless Steel Bronzed Steel

Configurations

Multiple configurations available

Wall Hardware

Prices from £POA (Ex VAT)

Our unique metal brackets we use to store freeweights and accessories on our wall units are now available for purchase. These are some of our most in demand pieces, and are perfect for integration into bespoke joinery planned for your gym space.

These brackets have been specifically designed to hold our products, and are available in both Steel and Bronze with a choice of a brushed or polished finish. They are designed to be fastened from the rear of the panel they are fixed to, and we strongly recommend you consult with a professional joiner before purchasing these for your project.

Metal Options



Stainless Steel Bronzed Steel

Configurations

Kettlebell hook, Medicine ball grid, Rope hook, Ball hoop, Dumbbell rack 5 pair, 6 pair, 7

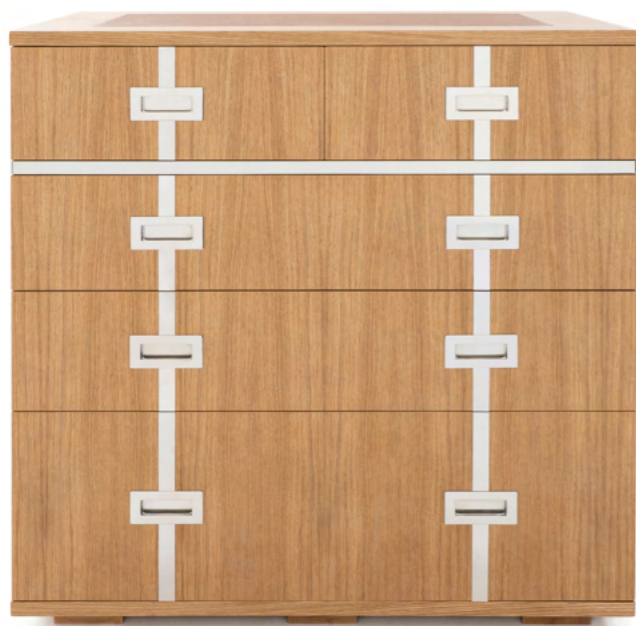

Credenza

Prices from £POA (Ex VAT)

Originally a custom piece made for a superyacht, our Credenza is a customisable, freestanding storage unit for small gym weights and accessories.

Our workshop use hand-flocked inserts to hold equipment in place inside the drawers, and the unit is configured so as to allow maximum capacity for storing all the items you would need for a great workout.

Each drawer uses a soft-close mechanism and can also have a locking latch at both ends in the event the unit will be used at sea.

Wood Options

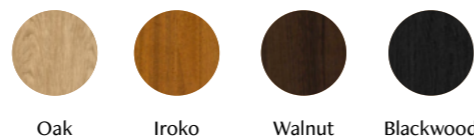

Metal Options



Configurations

Multiple configurations available



Ball Holder

Prices from £1,706 (Ex VAT)

A luxury gym should be beautifully presented at all times, which is why the storing of equipment is a key part of the Paragon Studio product range.

There will be no need for the exercise ball to be tucked into a corner or for the constant battle to stop it moving around the gym with the Paragon Studio Ball Holder.

Wood Options



Metal Options

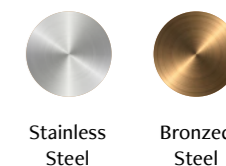

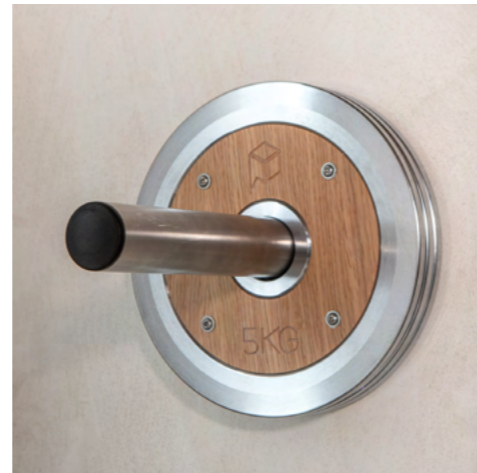

Olympic Plate Pin

£196 (Ex VAT)

The Paragon Studio Weight Storage Pin offers a practical and robust solution for discreet weight plate storage.

Designed to hold standard Olympic plates with a maximum load of 100kg, its compact 28cm length makes it ideal for any luxury gym – particularly at home.

Each pin features refined brushed stainless steel metalwork and a laser-engraved logo.

Bespoke set-outs are available for each drawer, designed solely around the Paragon Studio range of weights and accessories.

Max Weight

100kg

Metal Options



Stainless Steel



Hand Weight Tree

Prices from £8,872 (Ex VAT)

Introducing the Paragon Studio Luxury 1-10kg Hand Weights and Storage Tree package. Crafted for those who value both form and function, these hand weights are a stunning addition to any fitness regimen, offering a seamless blend of luxury and performance. Available in four luxurious wood finishes – Oak, Iroko, Walnut, or Blackwood – each pair of hand weights is meticulously handcrafted to highlight the natural beauty and unique grain patterns of the wood.

Wood Options



Oak



Iroko



Walnut



Blackwood

Metal Options



Stainless Steel



Bronzed Steel

Available Storage

10 pair

Custom Options

Sea fastening bracket

Material Options



Material Options

At Paragon Studio, we offer clients bespoke equipment across our entire collection. Alongside our standard selection of materials, our range of products can be made in any wood or metal finish you can imagine.

We encourage clients and designers to suggest their own material finishes for each individual component of the equipment, carefully matching and sampling new techniques where necessary to improve the final product.





Woods

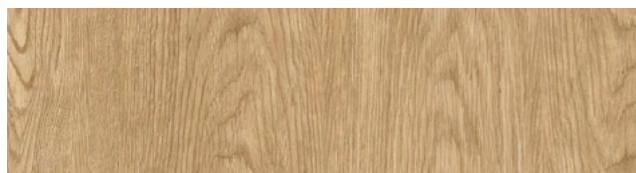

Oak

Elegant and classic, our European Oak is sourced from sustainable forests. The beautiful wood grain has a natural pattern, making each piece unique.

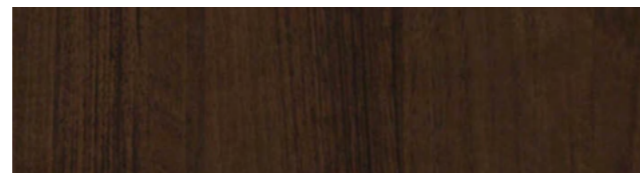

Walnut

Prized for its strength and durability, American Walnut has a velvety finish in its grain and a rich brown colour.



Iroko

A warm and rich wood, which is elegant and durable. We use Iroko in place of traditional Teak to ensure sustainable and ethical sourcing.



Blackwood

Deep black stained Oak which allows the natural wood grain to show through. Hand finished in the UK, this material holds its colour to stand the test of time.

Metals

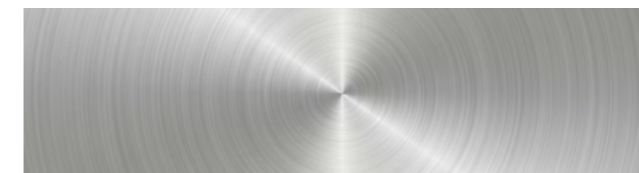

Stainless Steel

Elegant and hardwearing, Steel offers a uniform and highly reflective finish which compliments all interiors. Turned or polished with an elegant shine.

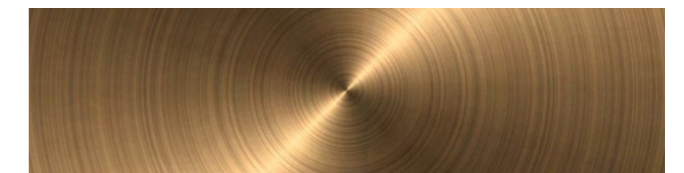

Bronzed Steel

A popular gold hue that is delicate yet opulent. Eclectic warm tones will tie your gym design together. We use Aluminium Bronze or PVD coating to achieve this look.

Finishes

Brushed

A textured and understated metal finish. Offers an all-purpose, textured effect that gives the metal a smooth, unidirectional appearance.

Polished

Hand treated metal with a highly-polished mirror finish characterised by a bright, shiny and reflective surface.



Leathers

**Leather is a natural material and shades may vary*

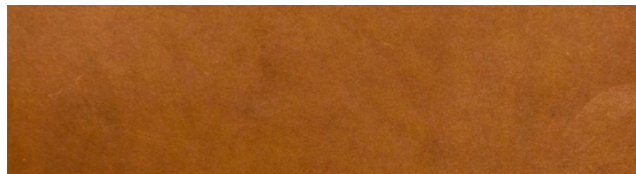

Tan

A sustainably sourced durable leather. Rich and velvety in colour, robust against cracking and wear, it gets better with time.

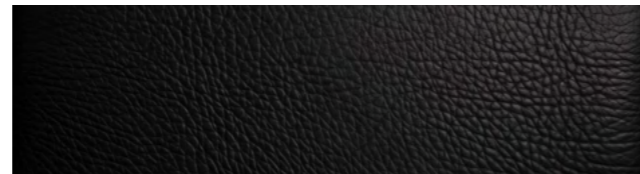

Black

A classic and timeless leather finish. Features a soft sheen that accentuates the textured appearance of the leather.

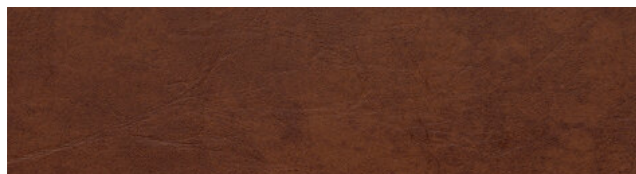

Brown

Easy to clean and condition, protecting against damage. Rich and earthy tones with a textured matte finish, a classic and subtle leather.



Cream

A rich and natural leather that resists fingerprints and scuff marks. Its light structure gives it an exceptionally soft, velvet-like texture.

Cork

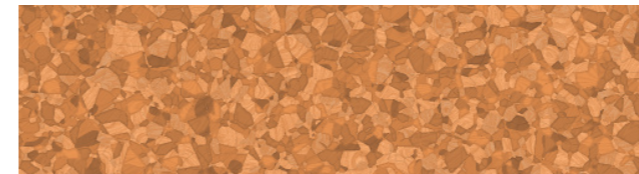

Natural Cork

A sustainable and soft finish for yoga equipment, cork offers low density cushioning. The perfect lightweight and durable material.

Custom Options



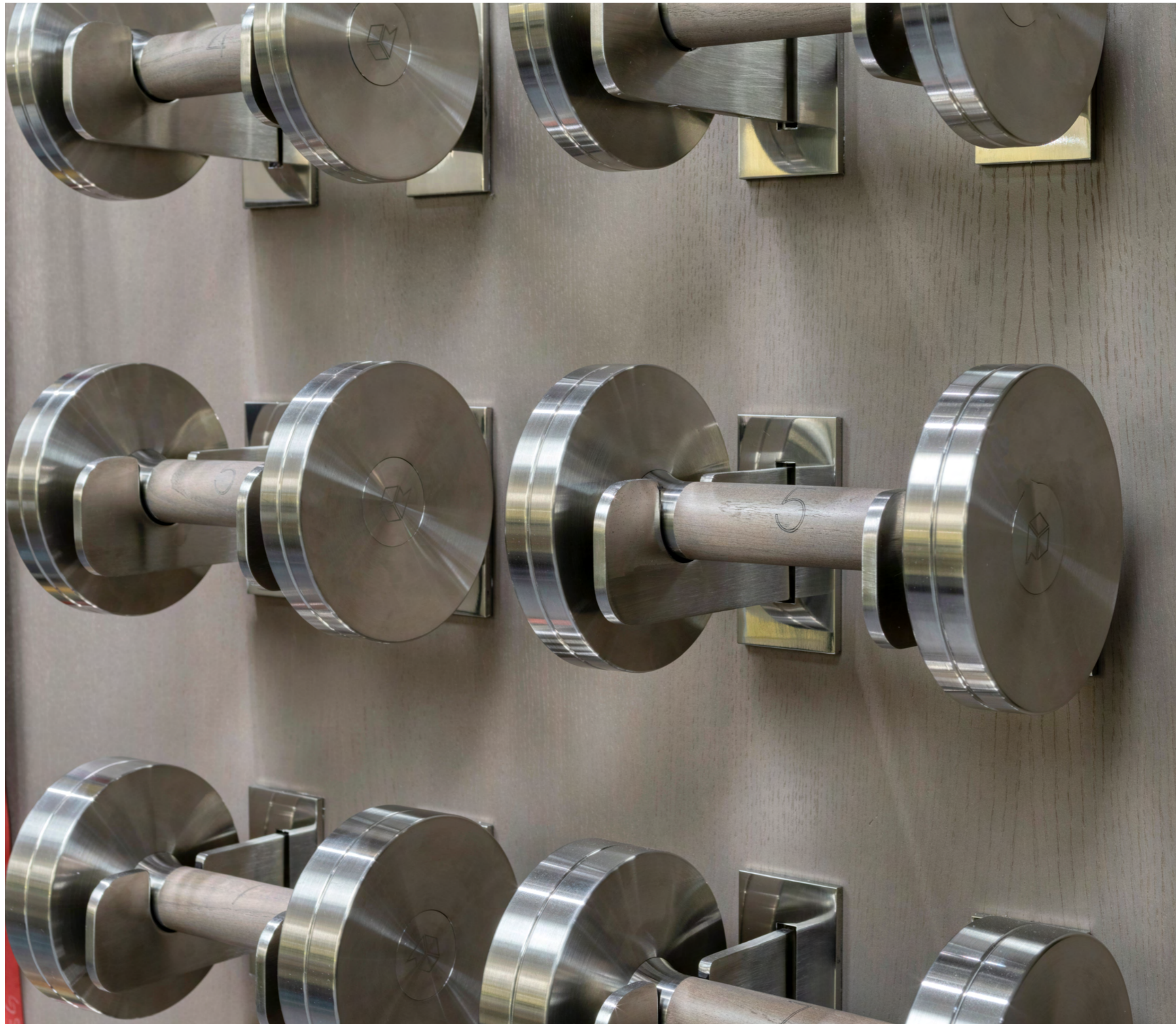

Custom Options

At Paragon Studio, our goal as a business is to combine the ergonomics of exercise with an aesthetic consideration which sets our gym designs apart from the average workout area. As a team, we have years of experience in creating highly desirable spaces, we go above and beyond creating customisable and bespoke pieces of equipment that are unique to each individual interior and client.

Our dumbbells feature the perfect surface to add your own bespoke logo with laser-etching. For this project, as well as using the property's own personal monogram, we created a bespoke stain to achieve this soft black wood finish which was designed to achieve a monochrome look throughout the gym, blending our equipment in with the cardio equipment.

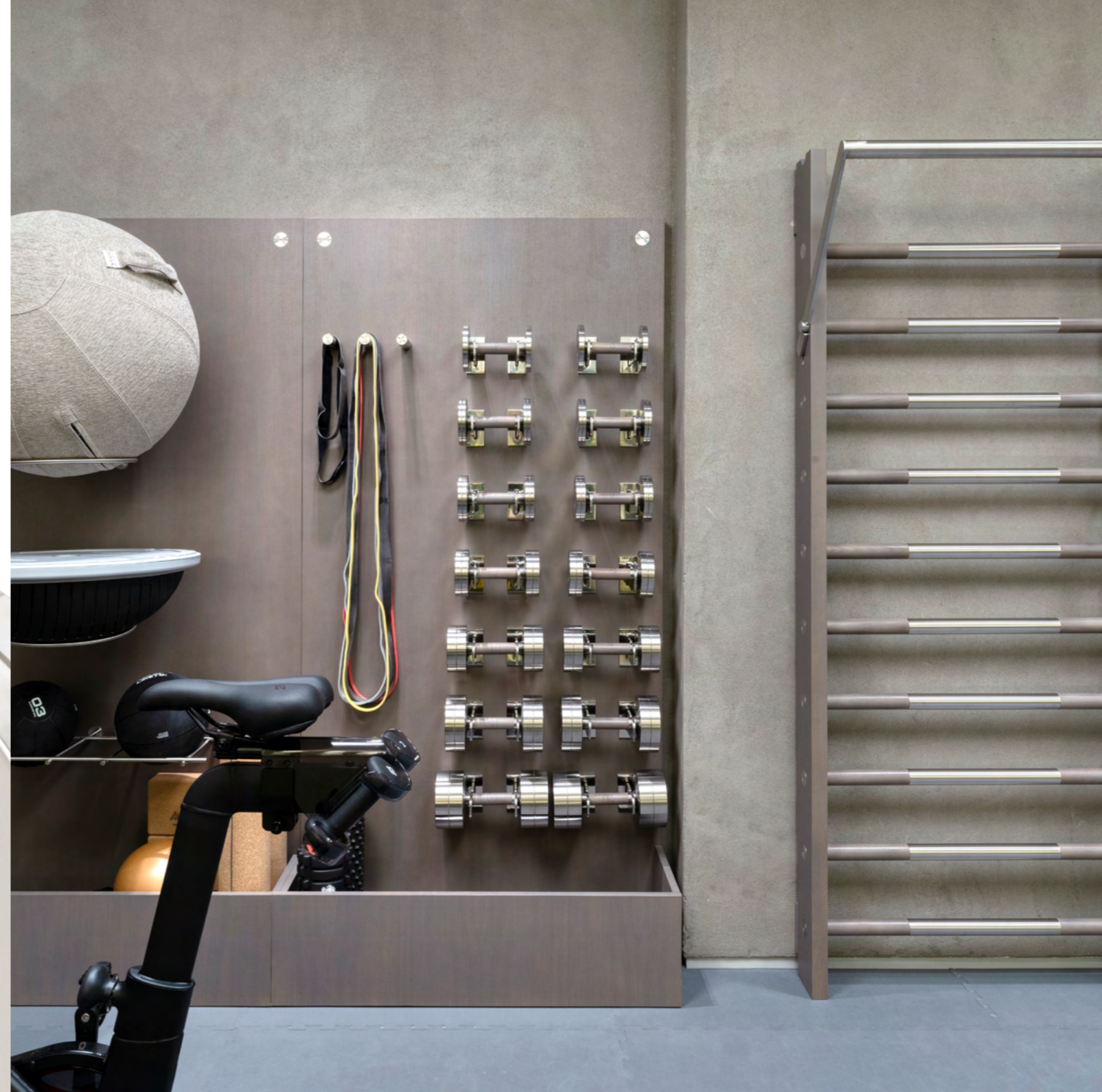

We recently completed our most ambitious project yet for some fantastic London based clients in their basement home gym. We were able to custom stain the wood on their equipment to seamlessly extend their already established interior aesthetics. Everything was chosen to coherently match and complement the design.

This project was completed for a major UK interior design firm who requested we use a mismatched wood for the dumbbell handles and racks.

A bespoke bleached Oak was used for the racking, and for the dumbbell handles our American Walnut was chosen.

As seen here on this project, if required, the end plates can be laser engraved so that weight increments can be clearly displayed in the centre of the surface. Equally, rubber bands can easily be incorporated around the discs of your weights. These bands protect both your weights and flooring from damage during use.



Case Studies



OWO Penthouse

The OWO Penthouse has been designed by international studio Winch Design, who combine their decades of experience in creating superyacht, private aircraft and residences for ultra-high net worth clients, with a timeless and joyful scheme that champions craftsmanship, artistry and the OWO's historical and cultural significance.

In the design of the five-bedroom lateral penthouse, Winch Design collaborated with over forty award-winning suppliers to craft and source bespoke pieces of furniture, fabrics,

artwork and accessories, creating a residence that feels carefully curated over time. Featuring a private gym and sauna, cinema and games room, staff quarters and expansive terraces with panoramic views, The OWO Penthouse is a truly one-of-a-kind residence.

We were delighted to outfit the gym space with equipment from our range, and the beautiful NOHRD Bike in Oak.



Chelsea Home Gym

This beautiful duplex apartment in London was totally refitted by its owner in the Summer of 2023 by Noba Interior Design.

Originally 2 separate dwellings, the properties were connected and turned into a single home for a client who frequently travels internationally for business, but has a passion for staying healthy.

Paragon Studio were commissioned to do a complete design of the gym including provision of bespoke

equipment in Oak and Steel; and recommendation of supplementary accessories and flooring.

For this ambitious project we created our first triple wall storage unit – with a new module to hold both dumbbells and kettlebells. This has now become a staple within our range of configurable storage options.

A NOHRD Slim Beam, also in Oak, completes the gym with a smart and compact cable training facility.

Arabian Ranches, Dubai

Nestled in a quiet corner in the Arabian Ranches neighbourhood, this effortlessly stylish home gym is the latest addition to a family home which has undergone an extensive redevelopment.

The owner was particularly forward thinking in the use of wall space to keep the floor area tidy, and our vertical wall storage options for free weights therefore suited the design perfectly.

The level of organisation in this gym is seriously impressive; every item has a hook or a dedicated storage box right down to individual pairs of gym trainers.

Overall this is a stunning space and we are very grateful to this wonderful family for allowing us to play a small part in their beautiful home.

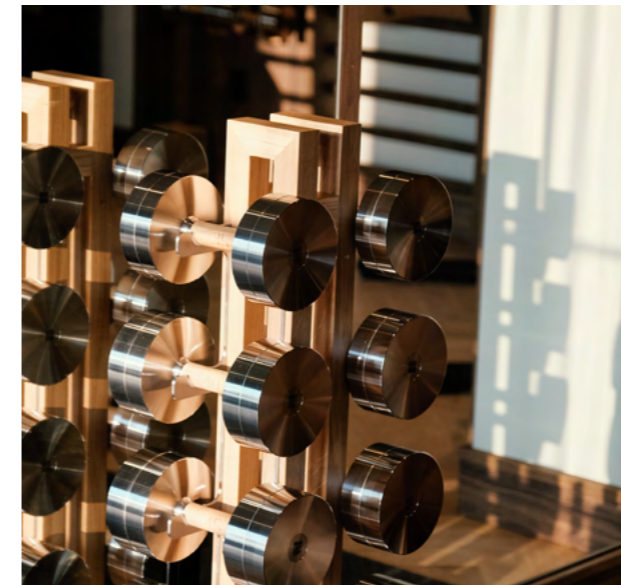

The Manchester Hotel

Working with the hotelier and his design team, Paragon Studio were delighted to be involved in this boutique gym project right in the heart of Lexington's famous Bourbon district.

The gym replicates the incredible finishes incorporated throughout the hotel; built to mirror Kentucky's unbridled enthusiasm, warm Southern light, and full-galoped feeling.

Our team worked on the gym layout design, and created a kit list including Paragon Studio's Adjustable Benches and Boxing equipment with the hotel logo debossed into the leather pads. We also specified Diabolo Dumbbells with the logo laser engraved into the end plates, matching racks and cork yoga equipment.

Lastly, Peloton and Precor were brought in to the project to complete the cardio and strength offering.



Tuscany Villa

This Tuscan Villa is owned by a family who are enthusiastic about their training and have gyms in their properties around the world. The project we completed in late 2023 with Pippa Paton Design.

The standout feature of this converted garage gym is the set of enormous glass doors at the front; letting in the light

and allowing fresh air to flood into the gym during the summer months when they are open.

Our equipment was specified in Oak and Steel, with heritage brown and tan leathers being chosen to meet the design brief.



Golden Goose Arena

Combining sport, sophistication, and exclusivity, the Golden Goose Arena venue presents a contemporary interpretation of the members' club experience – centred around the booming sport of Padel.

Golden Goose is a world famous Italian fashion brand, and this foray into sport plays into their core identity as a luxury marque which appeals to active and adventurous clients.

In addition to its state-of-the-art courts, the upper members' lounge offers a multifunctional environment for events and wellness activities.

A sweeping curtain reveals a bespoke wall installation conceived and executed by Paragon Studio, showcasing premium gym equipment and workout accessories distinguished by Golden Goose's iconic star emblem.



Ohio Family Home Gym

Located in a stunning family home in Ohio, this bespoke luxury gym project was a collaborative success between Paragon Studio, the homeowners, and Cloonan Design. Transforming an upper-level space, Paragon Studio meticulously designed a serene yet high-performance fitness area, seamlessly blending relaxation with rigorous training and the home's elegant aesthetic.

The gym features a comprehensive selection of premium equipment, including treadmills, benches, and free weights. A key design highlight is the unique material palette, which

creates a compelling contrast between the cold, metallic finish of the steel weights and the warm, custom powder-coated bronze finishes of the brackets and squat rack. To ensure a safe and clutter-free environment, we developed innovative vertical storage for weights and accessories, integrating custom hardware components into the millwork. This project exemplifies Paragon Studio's commitment to creating sophisticated, functional home gyms that enhance luxury residential spaces.

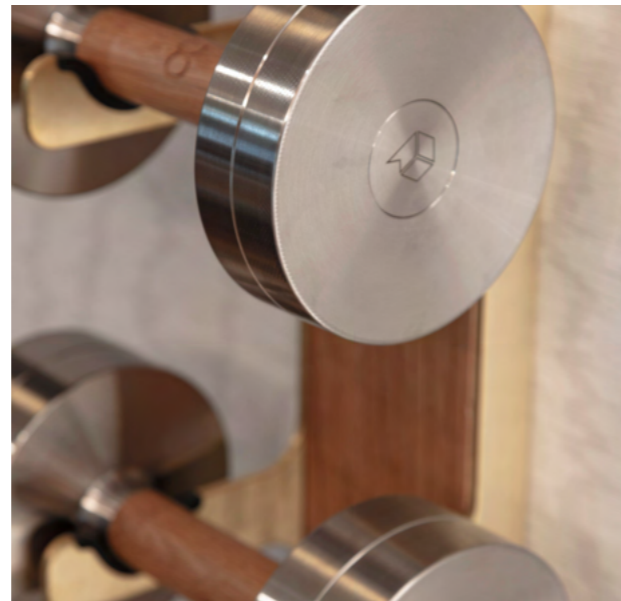

Partnerships



Paragon Studio x gym80 collaboration

The gym80 x Paragon Studio strength line comes as standard with a bespoke wooden element incorporated into each machine where possible; which the Paragon Studio workshop will produce to match other wooden equipment or joinery in the gym. Clients will be able to select from a range of modern paint colours, and will have the option to match upholstered pads to other leather products in the Paragon Studio range.

Gym80 is a German company which was founded in 1980, and is well known for producing strength machines of the highest quality and with industry-leading biomechanics. Gym80 also prides itself on offering clients the opportunity to fully customise their products; offering up numerous paint finishes and a huge range of luxury leather upholstery choices, as well as more unique customisations like laser-cut framework and shrouds which give machines the appearance of a piece of sculpture.

The collaboration covers all equipment in gym80's pin-select series; with over 100 different fixed strength stations with weight stacks available.





Showroom Locations

Now, you can explore our collection - we have showrooms to visit globally, including:

- HQ Battersea, London, UK

Equipment also on display with:

- VUORI Regent Street, London, UK
- VUORI Kings Road, London, UK
- VUORI Harrods, London, UK
- VUORI HQ, California, US
- SIRO One Za'abeel, Dubai, UAE
- Golden Goose Arena, Milano, Italy
- Pivot, Aspen, US
- Yours, Marbella, Spain

Designers Area



Designers Area

If you are an architect or professional interior designer, then we would love to invite you to our Designers Area on our website, where you will find all of our 2D and 3D models for use in your schemes.

Filetypes available include DWG, DXF, STEP, 3DS and SKP
Please contact us for information on how to access and to request any custom drawings you may not find online.

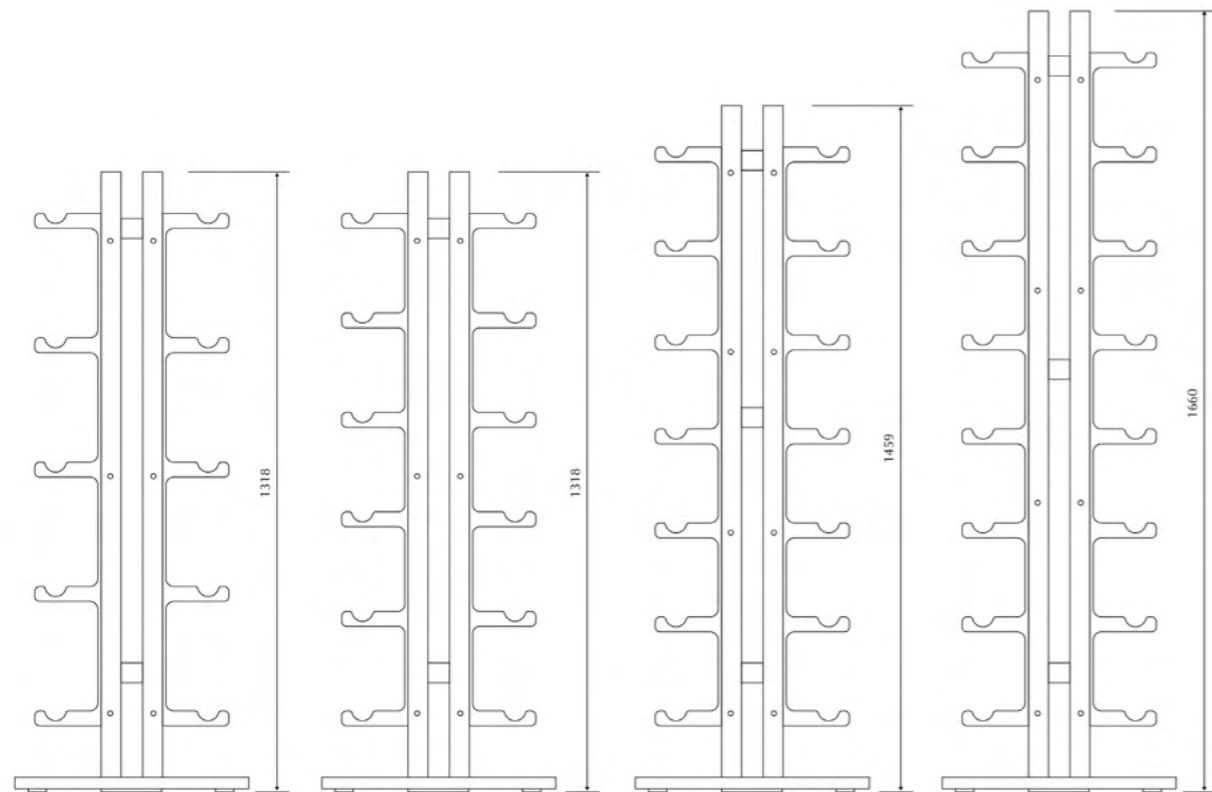





P A R A G O N
S T U D I O

+44 207 965 7262
hello@paragonstudio.co.uk
www.paragonstudio.co.uk